

FEATURES

- The normally closed LPG valves are especially designed to meet the particular heavy duty requirements of LPG applications
- Single flow execution for self service systems
- Explosion proof operator, intended for use in potentially explosive areas, according to Directive ATEX 94/9/EC
- Easy electrical installation by means of the moulded-in supply cable, standard length of 2 meter
- ASCO Numatics components satisfy all relevant EC directives

GENERAL

Differential pressure 0 - 25 bar [1 bar = 100kPa]
Ambient temperature range -20 to +65°C (FPM execution)
 -40 to +65°C (PTFE execution)

fluids (*)	temperature range (TS)	seal materials (*)
LPG / Liquid	-20 to +65°C	FPM (fluoroelastomer) / VMQ (silicone)
LPG / Liquid	-40 to +65°C	PTFE (**)

MATERIALS IN CONTACT WITH FLUID

(*) Ensure that the compatibility of the fluids in contact with the materials is verified
 (**) Specify suffix T behind catalogue number for the PTFE execution

Body & Bonnet	Brass
Core tube	Stainless steel
Core and plugnut	Stainless steel
Piston	Stainless steel
Core & Piston disc	FPM or PTFE
Rider ring	PTFE
Springs	Stainless steel

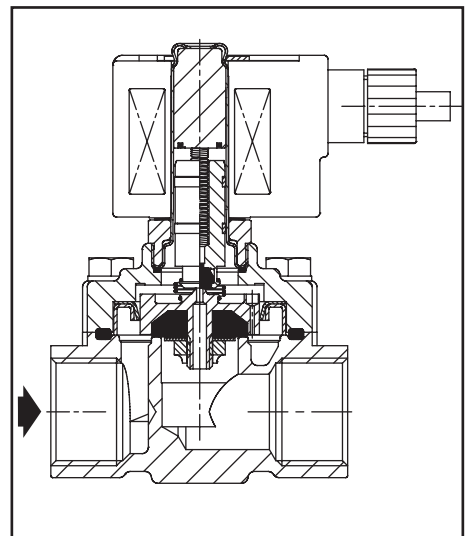

ELECTRICAL CHARACTERISTICS

Coil insulation class F
Electrical safety IEC 335
Standard voltages DC (=) 24V - 48V;
 AC (~) 24V - 48V - 115V - 230V / 50 Hz

prefix option	power ratings		operator ambient temperature range (TS) (C°)	safety code	electrical enclosure protection (EN 60529)	replacement coil		type ⁽¹⁾
	holding ~ (W)	hot/cold = (W)				~	=	
	230V/50/60 Hz	24V/DC						
PV	10,5	-	-40 to +65	II 2 G Ex mb II T3	moulded IP67	(2)	-	01
(WS)EM	-	12,0 / 16,8	-40 to +40	II 2 G Ex e mb II T3	SS / moulded IP65	-	(2)	02
SC	10,5	12,0 / 16,8	-40 to +65	EN 60730	moulded IP65	400425-117	400625-142	03 & 04

⁽¹⁾ Refer to the dimensional drawings on page 20
⁽²⁾ Multiple coils kits available under ATEX, contact us
 - Not available

SPECIFICATIONS

pipe size	orifice size		flow coefficient Kv				operating pressure differential (bar)			prefix optional solenoids *					basic catalogue number	
	Low	High	Low	High	min	max. PS		NEMA 7&9	ATEX / IECEx			IP65				
						~	=		Ex d	Ex e mb	Ex mb		EEx nA			
G	(mm)	(mm)	(m³/h)	(l/min)	(m³/h)	(l/min)			EF	NF	EM	PV	ZN	SC		
NC - Normally closed																
1/2	2,4	19	0,15	2,5	4,0	66,7	0	25	17	-	-	○	□	-	●	G291A310
3/4	2,4	19	0,15	2,5	4,0	66,7	0	25	17	-	-	○	□	-	●	G291A320

● Available feature ○ Available feature in DC only □ Available feature in AC only
 - Not available
 * For description of solenoids see pages 31-40

ADDITIONAL OPTIONS

- Other explosionproof enclosures for use in zone 1/21-2/22, categories 2-3 to ATEX Directive 94/9/EC
- Explosionproof and watertight solenoids according to "NEMA" standards

INSTALLATION

- The valves can be mounted in any position without affecting operation
- Pipe connection identifiers: G = pipe thread according to ISO 228/1
- Installation/maintenance instructions are included with each valve
- PV solenoids have a standard cable length of 2 meters. Other lengths in full meters are available on request

DIMENSIONS (mm), WEIGHT (kg)



TYPE 01
 Prefix "PV" Solenoid
 Epoxy encapsulated
 EN-IEC 60079-0, 60079-18, 61241-0, 61241-18
 II 2 G/D Ex mb II / Ex mD
 IP67

G291A321 / A320

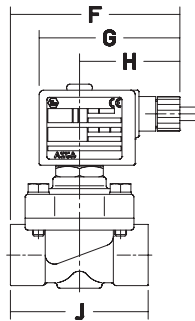
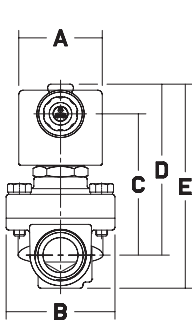

TYPE 02
 Prefix "EM" and "WSEM" Solenoid
 Zinc plated steel, epoxy coated (EM)
 Stainless steel, AISI 316 (WSEM)
 EN-IEC 60079-0, 60079-7, 60079-18, 61241-0, 61241-18
 II 2 G/D Ex e mb II / Ex tD
 IP67

G291A310 / A320

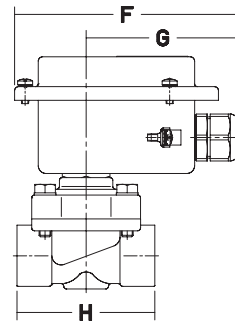
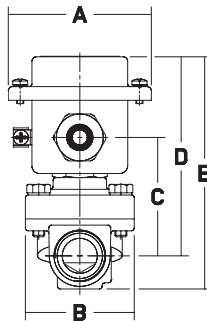

TYPE 03
 Prefix "SC" Solenoid
 Epoxy moulded
 IEC 335 / ISO 4400
 IP65

G291A310 / A320

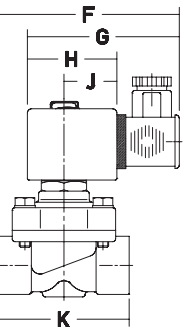
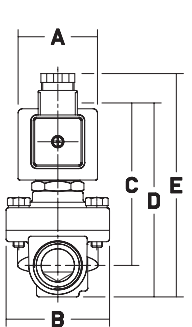

TYPE 04
 Prefix "SC" Solenoid
 Epoxy moulded
 IEC 335 / ISO 4400
 IP65

G291A310 / A320

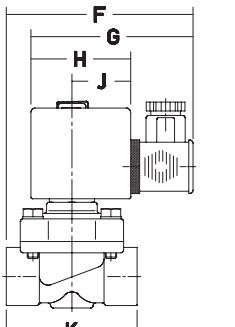
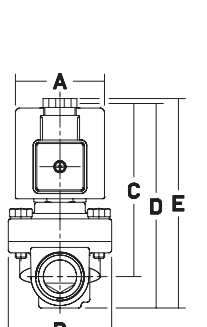

type	AC/DC	prefix option	catalogue number	spare parts kits	A	B	C	D	E	F	G	H	J	K	weight
01	~	PV	G291A310	PVC144067	45	58	71	87	101	88	75	54	70	-	1,1 Kg
			G291A320	PVC144064	45	58	75	91	109	90	75	54	73	-	1,2 Kg
02	=	(WS)EM	G291A310	EMC144072	76	58	59	102	116	120	82	70	-	-	1,3 Kg
			G291A320	EMC144069	76	58	63	106	124	120	82	73	-	-	1,4 Kg
03	~	SC	G291A310	C144067	45	58	87	101	118	100	85	50	30	70	1,0 Kg
			G291A320	C144064	45	58	91	109	125	102	85	50	30	73	1,1 Kg
04	=	SC	G291A310	C144072	50	58	93	107	110	103	91	56	33	70	1,2 Kg
			G291A320	C144069	50	58	97	115	118	105	91	56	33	73	1,3 Kg