

## GENERAL

<b>Fluid</b>	Air or neutral gas, non-lubricated, filtered at 25 µm
<b>Operating pressure</b>	7 bar max.
<b>Ambient temperature</b>	+5°C to +50°C
<b>Flow (Qv at 6 bar)</b>	See "specifications"
<b>Manual operator</b>	Impulse-type (without manual operator on request)
<b>Switching time</b>	10 ms (<10 ms on request)

## CONSTRUCTION

<b>Body</b>	PA (polyamide) MXD6
<b>Internal parts</b>	Stainless steel, nickel-plated steel, synthetic material, aluminium
<b>Seals</b>	NBR (nitrile), FPM (fluoroelastomer) on request

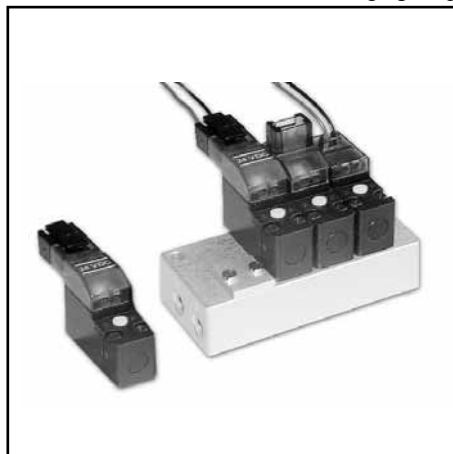

## ELECTRICAL CHARACTERISTICS

voltage (other voltages on request)	consumption	insulation class	degree of protection	electrical connection
24V = 12V = 5V =	1W - 1,3W	F	IP 40	connector with two 0.5 mm <sup>2</sup> lead wires + built-in LED and electrical protection or cable ends, 0,5 m long
+10%, -15%				

The solenoid valves are designed for continuous operation within the maximum ambient temperature limits.

## SPECIFICATIONS

symbol	orifice size (mm)		flow		operating pressure (bar)		consumption (W)	type of electrical connection (*)	catalogue number
	1 → 2	2 → 3	at 6 bar l/min (ANR)	coeff. Kv	min.	max.			
	0,5	0,7	8	0,12	0	8	1,3	1	<b>18801003</b>
								2	<b>18801076</b>
								3	<b>18801074</b>
								4	<b>18801078</b>
								5	<b>18801072</b>
	0,5	0,7	8	0,12	0	6	1,3	1	<b>18801063</b>
								2	<b>18801077</b>
								3	<b>18801075</b>
								4	<b>18801079</b>
								5	<b>18801073</b>

(\*) Type 1,2,3, 4 with LED and electrical protection  
 1 = horizontal, width 5,08 mm  
 2 = vertical, width 5,08 mm

3 = horizontal, width 2,54 mm  
 4 = vertical, width 2,54 mm  
 5 = cable ends 0,5 m long, 0,25 mm<sup>2</sup>

## OPTIONS

- versions with latching coil : consult us



**DIMENSIONS (mm), WEIGHT (kg)**



<b>weight</b>
0,0095

**type 1**

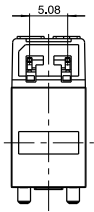
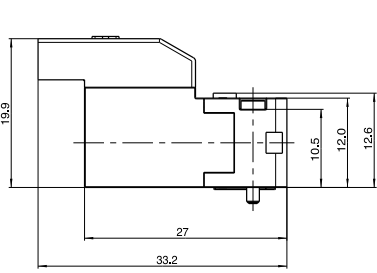

**Scale 1**

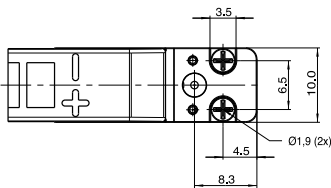

**type 2**

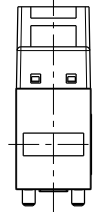
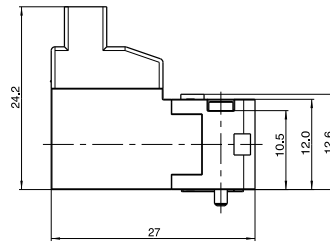

**Scale 1**

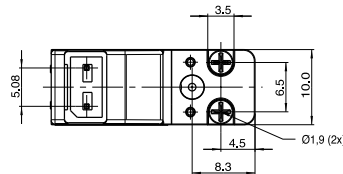

**type 3**

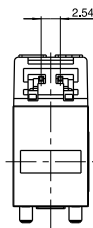
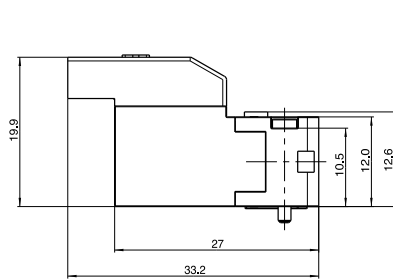

**Scale 1**

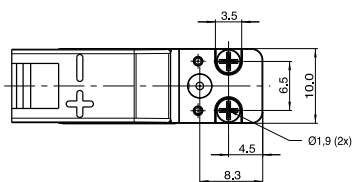

**type 4**

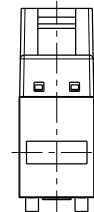
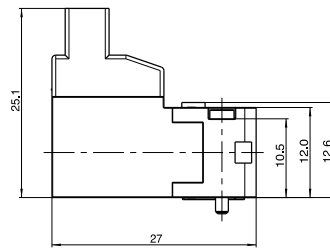

**Scale 1**

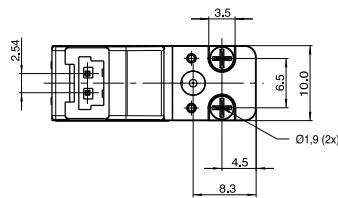

**type 5**

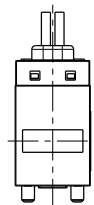
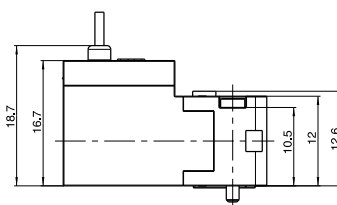

**Scale 1**

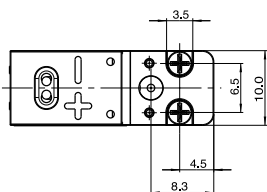

**flange facing**

<b>NO</b>
3 = Pressure
2 = Outlet
1 = Exhaust

<b>NC</b>
1 = Pressure
2 = Outlet
3 = Exhaust

<b>Use in vacuum (NO)</b>
3 = Vacuum pump
2 = Outlet
1 = Atmosphere

<b>Use in vacuum (NC)</b>
1 = Vacuum pump
2 = Outlet
3 = Atmosphere

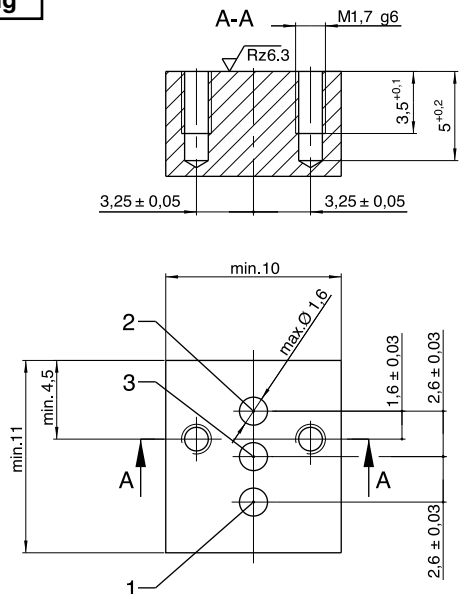

## DIMENSIONS (mm), WEIGHT (kg)

solenoid valve mounted on **single subbase**

number of valves	subbase catalogue number*	weight
1	35300101	0,015

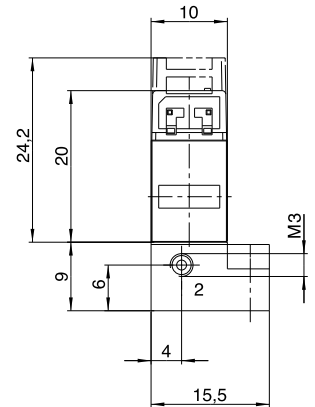
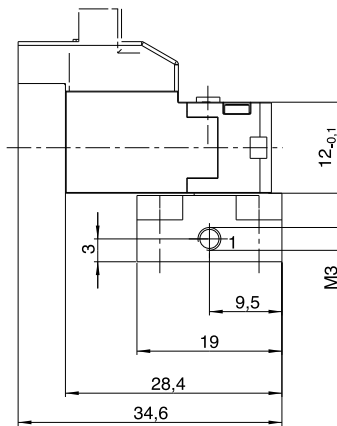
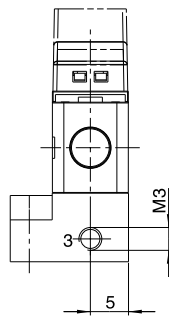

Scale 1

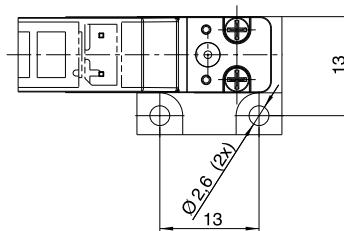

solenoid valve mounted on **multiple subbase**

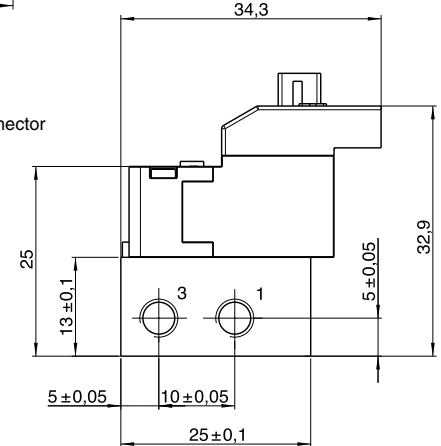
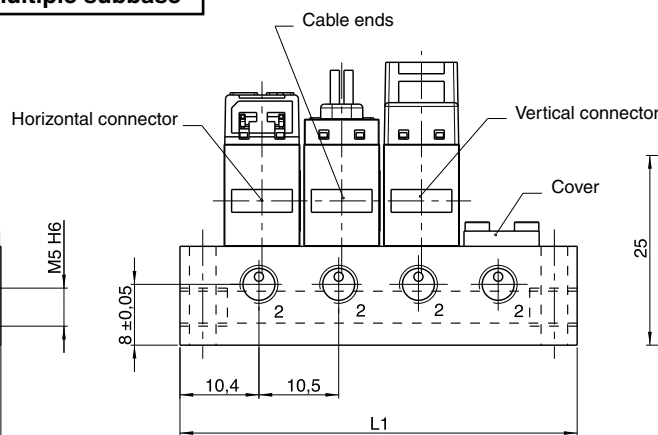
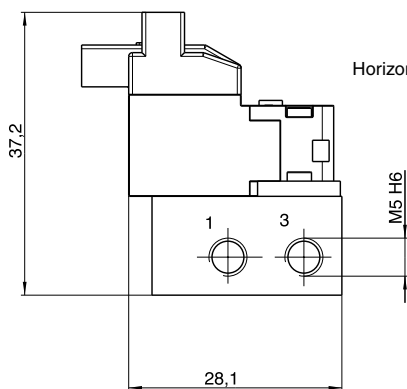

number of valves	subbase catalogue number*	length		weight
		L1	L2	
2	35300102	33,5	27,5	0,051
3	35300103	44	38	0,069
4	35300104	54,5	48,5	0,086
5	35300105	65	59	0,104
6	35300106	75,5	69,5	0,122
7	35300107	86	80	0,139
8	35300108	96,5	90,5	0,156
9	35300109	107	101	0,175
10	35300110	117,5	111,5	0,193

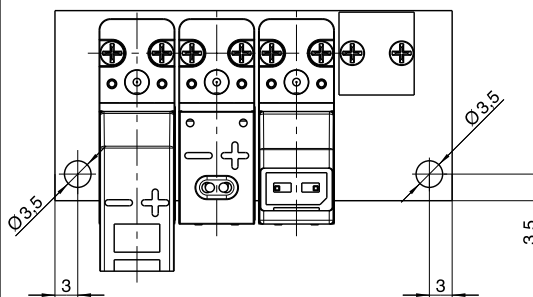

Scale 1

A : Blanking plate, **cat. no. 88135305**

\* The connectors must be ordered **separately**, please indicate the quantity and one of the following codes:

Connector, 2 wires

Distance between contacts 5,08 mm - Length 0,5 m - **cat. no.: 88118801**

- Length 1,5 m - **cat. no.: 88118802**

- Length 3 m - **cat. no.: 88118803**

Distance between contacts 2,54 mm - Length 0,5 m - **cat. no.: 88118806**

- Length 1,5 m - **cat. no.: 88118807**

- Length 3 m - **cat. no.: 88118808**

