

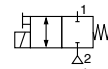

# MINIATURE SOLENOID VALVES

rocker mechanism, fluid isolation  
pad mounting body

2/2 NC



2/2 NO

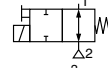

3/2 U

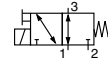

**2/2**  
**3/2**  
Series  
**260**  
**360**

## FEATURES

- Valves for medical analysers, biotechnology, gas analysers
- Can be used to control acids and bases, as well as analytical reagents
- Any application where the fluid may not come into contact with metal parts and with the electromagnetic control section of the solenoid valves
- The valves are ideal for controlling aggressive fluids or when high purity is demanded and have easy to flush internal cavities
- They can also be used as a very small internal volume flow-through sampling valve due to rocker technology
- Hermetic separation of control mechanism and fluid
- Reduced heat exchange between coil and fluid
- Protected manual operator
- The use of first class materials and thorough valve testing ensure high reliability and a lifetime of at least 1 million cycles
- The solenoid valves satisfy all relevant EC directives



## GENERAL

**Differential pressure** -0,7 to +2 bar (usable in 0,3 bar abs. vacuum) [1 bar =100 kPa]  
**Maximum viscosity** 20 cSt (mm<sup>2</sup>/s)  
**Response time** < 20 ms  
**Dead volume** < 0,75 µl (connections not included)

fluids (*)	temperature range (TS)	seal materials (*)
liquids or gases	0°C to + 40°C	EPDM (ethylene-propylene)

## CONSTRUCTION

**Body** PA12  
**Internal parts** Stainless steel

## MATERIALS IN CONTACT WITH FLUID

(\*) Ensure that the compatibility of the fluids in contact with the materials is verified

**Cover** PEEK  
**Diaphragm-poppets** EPDM  
**Base** PEEK  
**Seal of base** FPM

## ELECTRICAL CHARACTERISTICS

**Coil insulation class** F  
**Coil** Two spade terminals 2.8 x 0.5 mm (DIN 46340)  
**Electrical safety** IEC 335  
**Electrical enclosure protection** IP40 (EN60529)  
**Standard voltages** DC (=) : 12V - 24V  
 (Other voltages on request)

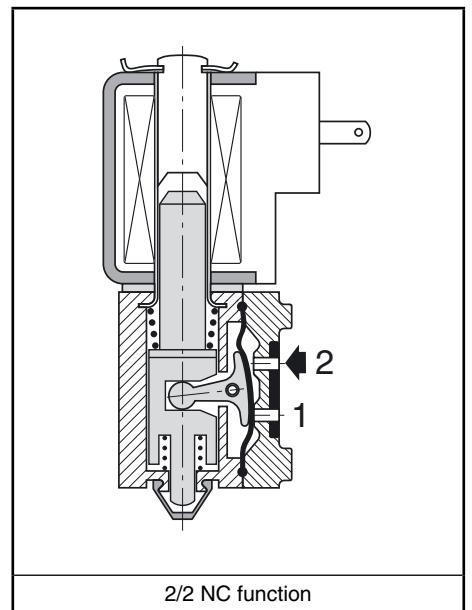

prefix option	power ratings			operator ambient temperature range (TS) (C°)	replacement coil		type <sup>(1)</sup>
	inrush	holding	hot/cold		-	=	
	~ (VA)	~ (VA) (W)	= (W)		-	24 V DC	
SC	-	-	4 / 5	-5 to + 40	-	43004663	01

<sup>(1)</sup> Refer to the dimensional drawings on the following page.

## SPECIFICATIONS

pipe size	orifice size (mm)	flow coefficient Kv (m <sup>3</sup> /h) (l/min)		operating pressure differential (bar)			power coil (W)		catalogue number (protected impulse manual operator)	options
		min.	max. (PS)	min.	max. (PS)	~	=			
								gases (*)		
<b>2/2 NC - Normally closed</b>										
pad mount	1,5	0,02	0,30	-0,7	2	2	-	5	<b>SCE260A420</b>	<b>V</b>
<b>2/2 NO - Normally open</b>										
pad mount	1,5	0,02	0,30	-0,7	2	2	-	5	<b>SCE260A430</b>	<b>V</b>
<b>3/2 U - Universal</b>										
pad mount	1,5	0,05	0,75	-0,7	2	2	-	5	<b>SCE360A420</b>	<b>V</b>

### OPTIONS

- Other diaphragm materials are available
- Other subbase, contact us

### INSTALLATION

- The solenoid valves can be mounted in any position without affecting operation
- Standard mounting holes provided at the rear end of the body
- Replacement coils are available
- Installation/maintenance instructions are included with each valve

### DIMENSIONS (mm), WEIGHT (kg)



**TYPE 01**  
Prefix "SC" Solenoid  
DIN 43340

**SCE260A420/430**  
**SCE360A420**

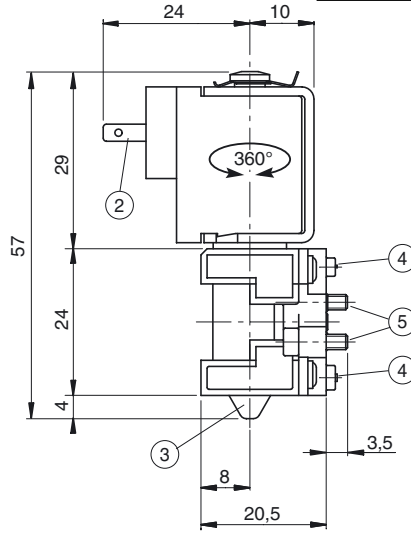
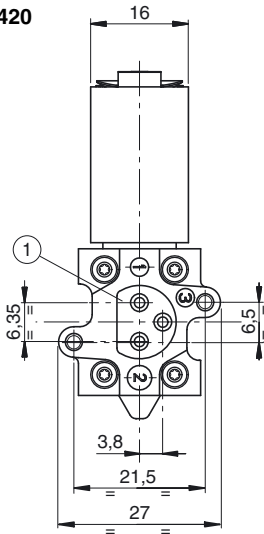

### ORDERING EXAMPLES:

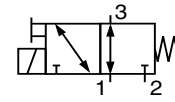
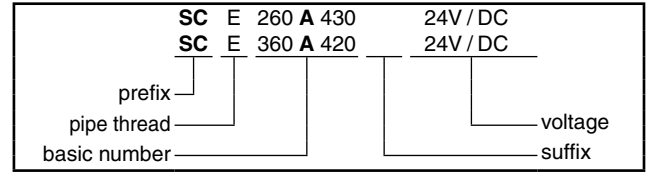

- ① Seal (FPM)
- ② Coil with two spade terminals 2,8 x 0,5 (DIN 46340)
- ③ Protected impulse type manual operator
- ④ Polarizing slots, ports markings
- ⑤ Mounting: 2 M2,5 x 8 screws, supplied

type	prefix option	weight <sup>(1)</sup>
01	SC	0,49

<sup>(1)</sup> Incl. coil.

Pad mounting according to function :

